

10" Woodworking Bandsaw



Operator's Manual

Record the serial number and date of purchase in your manual for future reference.

Serial Number: _____ Date of purchase: _____

For technical support or parts questions, email techsupport@rikontools.com or call toll free at (877)884-5167

TABLE OF CONTENTS

Specifications.....	2
Safety Instructions	3 - 6
Contents of Package	7
Assembly	7 - 8
Getting To Know Your Bandsaw	8
Adjustments.....	9 - 11
Operation	11
Maintenance	11
Wiring Diagram	12
Troubleshooting	12 - 15
Parts Diagrams & Parts Lists	16 - 19
Notes	20
Accessories	21
How To Guide for all Band Saw Blades	22
Warranty	23

SPECIFICATIONS

Model No.	10-305
Motor	
Horsepower	1/3 HP
Amps	3.5
Volts	110V, 60 Hz
Speed Range	2,780 FT/MIN
Cutting Capacity	
Height	4-5/8"
Width	9-5/8"
Blade	
Width	1/8" - 1/2"
Length	70-1/2"
Table	
Size	13-3/4" x 12-1/2"
Left Tilt	0°
Right Tilt	45°
Miter Gauge Slot	(1) 3/8" x 5/8"
Height to Floor	39-7/8" (On Stand)
Overall	
Height	33-1/4"
Width	21"
Depth	15-1/4"
Base Size	9-3/8" x 15-7/8"
Net Weight	68 lbs.
Shipping Weight	76 lbs.
Shipping Carton	35-1/2" x 12-3/4" x 18-1/4"
Warranty	5 Years

SAFETY INSTRUCTIONS

IMPORTANT! Safety is the single most important consideration in the operation of this equipment. **The following instructions must be followed at all times.** Failure to follow all instructions listed below may result in electric shock, fire, and/or serious personal injury.

There are certain applications for which this tool was designed. We strongly recommend that this tool not be modified and/or used for any other application other than that for which it was designed. If you have any questions about its application, do not use the tool until you have contacted us and we have advised you.

SAFETY SYMBOLS



SAFETY ALERT SYMBOL: Indicates DANGER, WARNING, or CAUTION. This symbol may be used in conjunction with other symbols or pictographs.



Indicates an imminently hazardous situation, which, if not avoided, could result in death or serious injury.



Indicates a potentially hazardous situation, which, if not avoided, could result in death or serious injury.



Indicates a potentially hazardous situation, which, if not avoided, could result in minor or moderate injury.

NOTICE: Shown without Safety Alert Symbol indicates a situation that may result in property damage.

GENERAL SAFETY

KNOW YOUR POWER TOOL. Read the owner's manual carefully. Learn the tool's applications, work capabilities, and its specific potential hazards.

BEFORE USING YOUR MACHINE

To avoid serious injury and damage to the tool, read and follow all of the Safety and Operating Instructions before operating the machine.

1. Some dust created by using power tools contains chemicals known to the State of California to cause cancer, birth defects, or other reproductive harm.

Some examples of these chemicals are:

- Lead from lead-based paints.
- Crystalline silica from bricks, cement, and other masonry products.
- Arsenic and chromium from chemically treated lumber.

Your risk from these exposures varies, depending on how often you do this type of work. To reduce your exposure to these chemicals: work in a well ventilated area and work with approved safety equipment, such as those dust masks that are specially designed to filter out microscopic particles.

2. **READ** the entire Owner's Manual. **LEARN** how to use the tool for its intended applications.

3. **GROUND ALL TOOLS.** If the tool is supplied with a 3 prong plug, it must be plugged into a 3-contact electrical receptacle. The 3rd prong is used to ground the tool and provide protection against accidental electric shock. **DO NOT** remove the 3rd prong. See Grounding Instructions on the following pages.

4. **AVOID A DANGEROUS WORKING ENVIRONMENT.** **DO NOT** use electrical tools in a damp environment or expose them to rain.

5. **DO NOT** use electrical tools in the presence of flammable liquids or gasses.

6. **ALWAYS** keep the work area clean, well lit, and organized. **DO NOT** work in an environment with floor surfaces that are slippery from debris, grease, and wax.

7. **KEEP VISITORS AND CHILDREN AWAY. DO NOT** permit people to be in the immediate work area, especially when the electrical tool is operating.

8. **DO NOT FORCE THE TOOL** to perform an operation for which it was not designed. It will do a safer and higher quality job by only performing operations for which the tool was intended.

9. **WEAR PROPER CLOTHING. DO NOT** wear loose clothing, gloves, neckties, or jewelry. These items can get caught in the machine during operations and pull the operator into the moving parts. The user must wear a protective cover on their hair, if the hair is long, to prevent it from contacting any moving parts.

10. **CHILDPROOF THE WORKSHOP AREA** by removing switch keys, unplugging tools from the electrical receptacles, and using padlocks.

11. **ALWAYS UNPLUG THE TOOL FROM THE ELECTRICAL RECEPTACLE** when making adjustments, changing parts or performing any maintenance.

SAFETY INSTRUCTIONS

12. **KEEP PROTECTIVE GUARDS IN PLACE AND IN WORKING ORDER.**

13. **AVOID ACCIDENTAL STARTING.** Make sure that the power switch is in the “OFF” position before plugging in the power cord to the electrical receptacle.

14. **REMOVE ALL MAINTENANCE TOOLS** from the immediate area prior to turning “ON” the machine.

15. **USE ONLY RECOMMENDED ACCESSORIES.** Use of incorrect or improper accessories could cause serious injury to the operator and cause damage to the tool. If in doubt, check the instruction manual that comes with that particular accessory.

16. **NEVER LEAVE A RUNNING TOOL UNATTENDED.** Turn the power switch to the “OFF” position. **DO NOT** leave the tool until it has come to a complete stop.

17. **DO NOT STAND ON A TOOL.** Serious injury could result if the tool tips over, or you accidentally contact the tool.

18. **DO NOT** store anything above or near the tool where anyone might try to stand on the tool to reach it.

19. **MAINTAIN YOUR BALANCE. DO NOT** extend yourself over the tool. Wear oil resistant rubber soled shoes. Keep floor clear of debris, grease, and wax.

20. **MAINTAIN TOOLS WITH CARE.** Always keep tools clean and in good working order. Keep all blades and tool bits sharp, dress grinding wheels and change other abrasive accessories when worn.

21. **EACH AND EVERY TIME, CHECK FOR DAMAGED PARTS PRIOR TO USING THE TOOL.** Carefully check all guards to see that they operate properly, are not damaged, and perform their intended functions. Check for alignment, binding or breaking of moving parts. A guard or other part that is damaged should be immediately repaired or replaced.

22. **DO NOT OPERATE TOOL WHILE TIRED, OR UNDER THE INFLUENCE OF DRUGS, MEDICATION OR ALCOHOL.**

23. **SECURE ALL WORK.** Use clamps or jigs to secure the workpiece. This is safer than attempting to hold the workpiece with your hands.

24. **STAY ALERT, WATCH WHAT YOU ARE DOING, AND USE COMMON SENSE WHEN OPERATING A POWER TOOL.**

A moment of inattention while operating power tools may result in serious personal injury.

25. **ALWAYS WEAR A DUST MASK TO PREVENT INHALING DANGEROUS DUST OR AIRBORNE PARTICLES,** including wood dust, crystalline silica dust and asbestos dust. Direct particles away from face and body. Always operate tool in well ventilated area and provide for proper dust removal. Use dust collection system wherever possible. Exposure to the dust may cause serious and permanent respiratory or other injury, including silicosis (a serious lung disease), cancer, and death. Avoid breathing the dust, and avoid prolonged contact with dust. Allowing dust to get into your mouth or eyes, or lay on your skin may promote absorption of harmful material. Always use properly fitting NIOSH/OSHA approved respiratory protection appropriate for the dust exposure, and wash exposed areas with soap and water.

26. **USE A PROPER EXTENSION CORD IN GOOD CONDITION.** When using an extension cord, be sure to use one heavy enough to carry the current your product will draw. The table on the following page shows the correct size to use depending on cord length and nameplate amperage rating. If in doubt, use the next heavier gauge. The smaller the gauge number, the larger diameter of the extension cord. If in doubt of the proper size of an extension cord, use a shorter and thicker cord. An undersized cord will cause a drop in line voltage resulting in a loss of power and overheating.
USE ONLY A 3-WIRE EXTENSION CORD THAT HAS A 3-PRONG GROUNDING PLUG AND A 3-POLE RECEPTACLE THAT ACCEPTS THE TOOL'S PLUG.

27. **ADDITIONAL INFORMATION** regarding the safe and proper operation of this product is available from:

- Power Tool Institute
1300 Summer Avenue
Cleveland, OH 44115-2851
www.powertoolinstitute.org
- National Safety Council
1121 Spring Lake Drive
Itasca, IL 60143-3201
www.nsc.org
- American National Standards Institute
25 West 43rd Street, 4th Floor
New York, NY 10036
www.ansi.org
- ANSI 01.1 Safety Requirements for
Woodworking Machines and the
U.S. Department of Labor regulations
www.osha.gov

28. **SAVE THESE INSTRUCTIONS.** Refer to them frequently and use them to instruct others.

SAFETY INSTRUCTIONS

ELECTRICAL SAFETY

⚠ WARNING:

THIS TOOL REQUIRES A 3-PRONG 110V RECEPTACLE, AND MUST BE GROUNDED WHILE IN USE TO PROTECT THE OPERATOR FROM ELECTRIC SHOCK.

IN THE EVENT OF A MALFUNCTION OR BREAKDOWN, grounding provides the path of least resistance for electric current and reduces the risk of electric shock. This tool is equipped with an electric cord that has an equipment grounding conductor. The plug **MUST** be plugged into a matching electrical receptacle that is properly installed and grounded in accordance with **ALL** local codes and ordinances.

DO NOT MODIFY ANY PLUG. If it will not fit the electrical receptacle, have the proper electrical receptacle installed by a qualified electrician.

IMPROPER ELECTRICAL CONNECTION of the equipment grounding conductor can result in risk of electric shock. The conductor with the green insulation (with or without yellow stripes) is the equipment grounding conductor. **DO NOT** connect the equipment grounding conductor to a live terminal if repair or replacement of the electric cord or plug is necessary.

CHECK with a qualified electrician or service personnel if you do not completely understand the grounding instructions, or if you are not sure the tool is properly grounded when installing or replacing a plug.

USE ONLY A 3-WIRE EXTENSION CORD THAT HAS A 3-PRONG GROUNDING PLUG AND A 3-POLE RECEPTACLE THAT ACCEPTS THE TOOL'S PLUG. *

REPLACE A DAMAGED OR WORN CORD IMMEDIATELY.

This tool is intended for use on a circuit that has a 110 volt electrical receptacle. **FIGURE 1** shows the type of the 110v, 3-wire electrical plug and electrical receptacle that has a grounding conductor that is required.

* Canadian electrical codes require extension cords to be certified SJT type or better.

** The use of an adapter in Canada is not acceptable.

EXTENSION CORDS

⚠ WARNING: Keep the extension cord clear of the working area. Position the cord so that it will not get caught on lumber, tools or other obstructions while you are working with a power tool.

⚠ WARNING: Check extension cords before each use. If damaged replace immediately. Never use a tool with a damaged cord, since touching the damaged area could cause electrical shock, resulting in serious injury.

Use a proper extension cord. Only use cords listed by Underwriters Laboratories (UL). Other extension cords can cause a drop in line voltage, resulting in a loss of power and overheating of tool. When operating a power tool outdoors, use an outdoor extension cord marked "W-A" or "W". These cords are rated for outdoor use and reduce the risk of electric shock.

MINIMUM RECOMMENDED GAUGE FOR EXTENSION CORDS (AWG)

120 VOLT OPERATION ONLY				
	25' LONG	50' LONG	100' LONG	150' LONG
0 to 6 Amps	18 AWG	16 AWG	16 AWG	14 AWG
6 to 10 Amps	18 AWG	16 AWG	14 AWG	12 AWG
10 to 12 Amps	16 AWG	16 AWG	14 AWG	12 AWG



THIS SYMBOL DESIGNATES THAT THIS TOOL IS LISTED BY THE INTERTEK TESTING SERVICES, TO UNITED STATES AND CANADIAN STANDARDS.

Sample of 110 volt plug required for this machine.

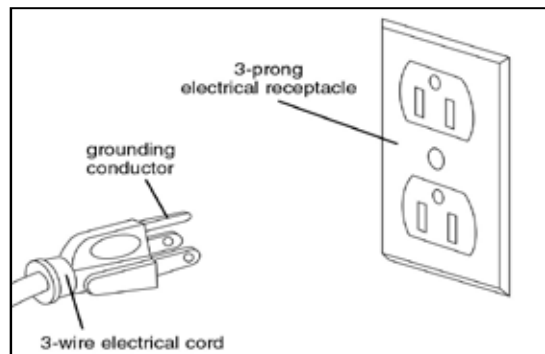

Figure 1

SAFETY INSTRUCTIONS

SPECIFIC SAFETY INSTRUCTIONS FOR BAND SAWS

1. Always allow the bandsaw blade to stop before removing scrap pieces from table.
2. Always keep hands and fingers away from the blade.
3. Never attempt to saw stock that does not have a flat surface, unless a suitable support is used.
4. Always hold material firmly and feed it into the blade at a moderate speed.
5. Always turn off the machine if the material is to be backed out of an uncompleted cut.
6. Adjust the upper guide about 1/8" to 1/4" above the material being cut.
7. Check for proper blade size and type for thickness and type of material being cut.
8. Make sure that the blade tension and blade tracking are properly adjusted.
9. Make "relief" cuts before cutting long curves.
10. Release blade tension when the saw will not be used for a long period of time.

California Proposition 65 Warning

WARNING: Some dust created by power sanding, sawing, grinding, drilling, and other construction activities contains chemicals known to the State of California to cause cancer and birth defects or other reproductive harm. Your risk from exposure to these chemicals varies, depending on how often you do this type of work. To reduce your exposure, work in a well-ventilated area and with approved safety equipment, such as dust masks that are specially designed to filter out microscopic particles.

For more detailed information about California Proposition 65 log onto rikontools.com.



This owner's manual is not a teaching aid. Use of this owner's manual is intended to show assembly, adjustments, and general use.

**SAVE THESE INSTRUCTIONS.
Refer to them often.**

NOTE: The specifications, photographs, drawings and information in this manual represent the current model when the manual was prepared. Changes and improvements may be made at any time, with no obligation on the part of Rikon Power Tools, Inc. to modify previously delivered units. Reasonable care has been taken to ensure that the information in this manual is correct, to provide you with the guidelines for the proper safety, assembly and operation of this machine.

ASSEMBLY

1. TOOLS REQUIRED FOR ASSEMBLY

Qty.	Item	Description
		Medium Screwdriver.....1
		Adjustable Wrench.....1
		Square1

2. UNPACKING AND CHECKING CONTENTS

The 10-305 10" Bandsaw is shipped complete in one box.

a. Separate all parts from carton and check each item with "Table of Carton Contents" to make sure all items are accounted for, before discarding any packing material.

b. Remove the protective oil that is applied to the table. Use any ordinary house hold type grease and spot remover.

c. Apply a coat of paste wax to the table to prevent rust. Wipe all parts thoroughly with a clean dry cloth.

CARTON CONTENTS

Item	Description	Qty
A	Main Machine.....	1
B	Fence.....	1
C	Table.....	1
D	Guide Rail.....	1
E	Manual.....	1
F	Upper Table Trunnion Assembly.....	1
G	Bag of Loose Parts.....	1

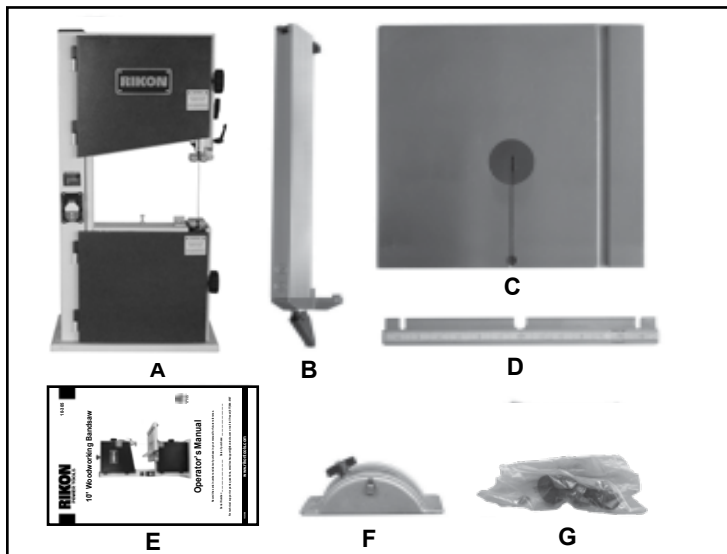

LIST OF LOOSE PARTS IN BAG

Item	Description	Qty
	Blade Tension Knob.....	1
	Hex. Socket Head Cap Screw M6x30.....	1
	Washer 6.....	1
	Wing Nut M6.....	1
	Hex. Bolt M6x12.....	4
	Lock Washer 6.....	4
	Star Knob Screw.....	2
	Washer 6	2
	M3 Hex "L" Wrench.....	1
	M5 Hex "L" Wrench.....	1

2. INITIAL ASSEMBLY

The machine is supplied partly assembled. Prior to use, the following items have to be installed: Table, Blade Tension Knob and Rip Fence.

WARNING: To Avoid injury, do not attempt to run or use this machine until all parts are assembled and working properly.

a. Assemble the upper table trunnion to the lower table trunnion with Carriage Bolt, Glide Piece, Washer and Wing Nut. Place the table on to the upper table trunnion, taking care when passing the saw blade through the slot of the table (See Fig. 1).

Locate four hex bolts and four lock washers from the bag of loose parts. Mount the table to the upper table trunnion and install a bolt with washer in each hole, then tighten with adjustable wrench.

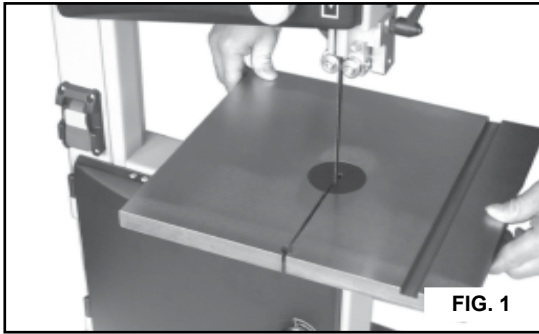

FIG. 1

b. Fasten the guide rail with two each star knob screw and washer to the table. Use the hex socket head cap screw, washer and wing nut for correcting the working table flatness. (See Fig. 2)

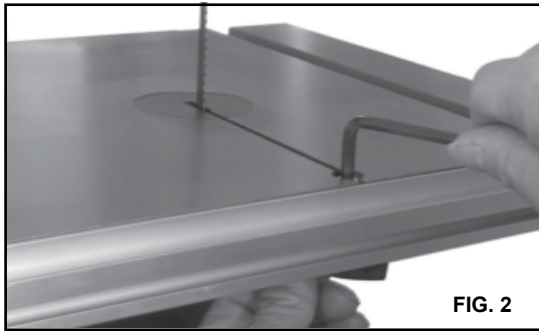

FIG. 2

c. Lay the rip fence onto the guide rail. Adjust the rip fence parallel to the saw blade. Tighten rip fence handle by pressing downward. (See Fig. 3)

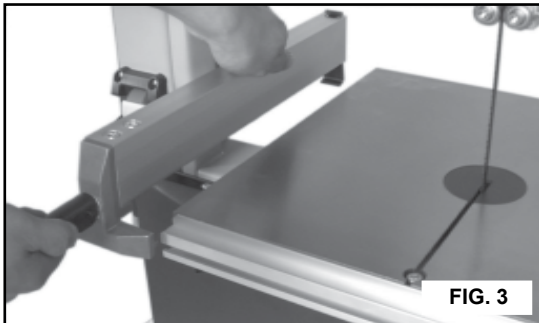

FIG. 3

d. Place the blade tension knob on to the blade tensioner located at the top of the frame (See Fig. 4).

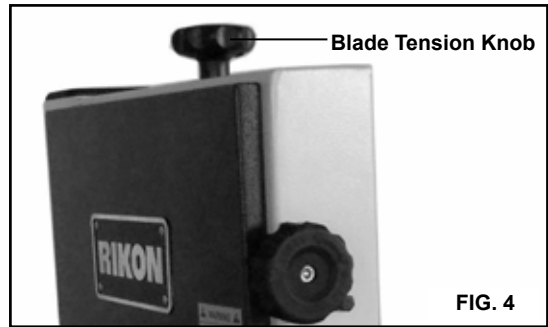

FIG. 4

e. To ensure sufficient upright stability of the machine it should be bolted to floor, bench or worktable. For this purpose 6mm holes are provided in the machine's base. (See Fig. 5)



FIG. 5

f. The bandsaw has a 2-1/2" dust port included. (See Fig. 6) It is recommended that when in use, the bandsaw is connected to a suitable dust collector.

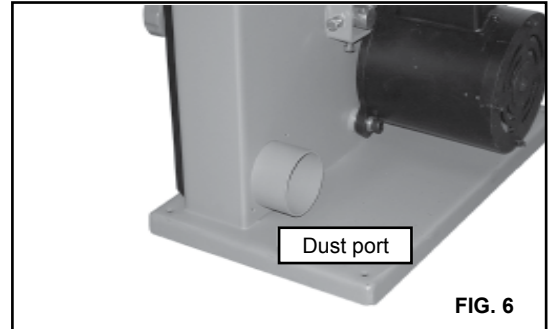
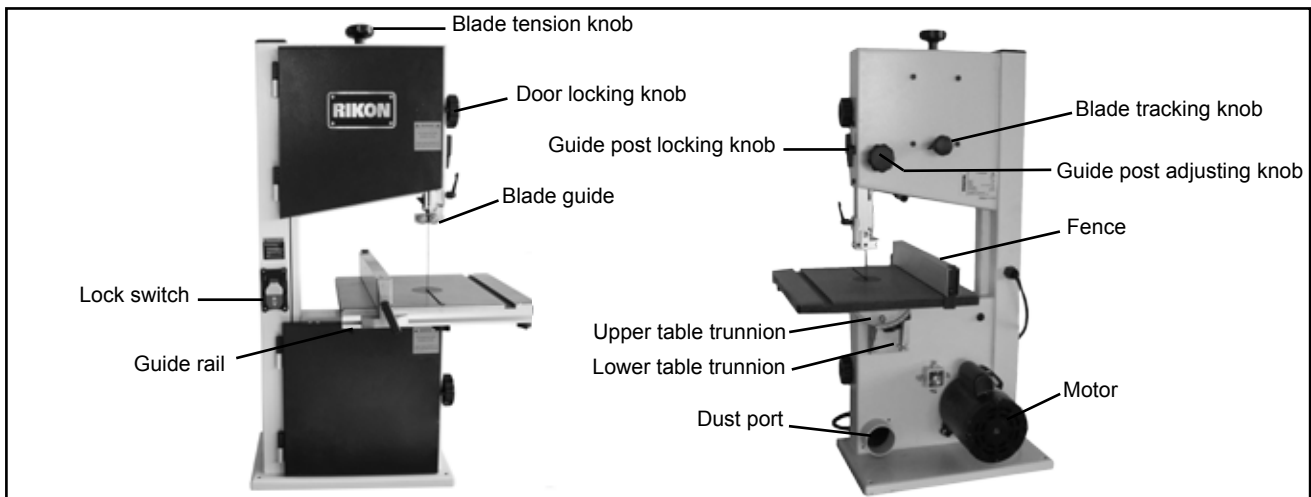

FIG. 6

GETTING TO KNOW YOUR BANDSAW



ADJUSTMENT

1. CENTERING THE TABLE

a. Loosen the four hex. bolts mounting the table to the upper table trunnion. (See Fig. 7)

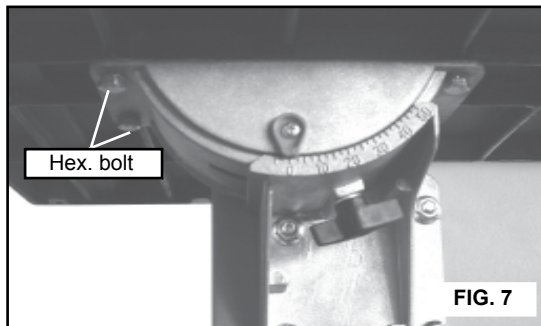

- b. Move the table sideways as required, until the saw blade runs through the center of the table insert.
- c. If the adjustment of "b" is not enough to center the table, loosen the four flange nuts holding the lower table trunnion and move the table sideways to place the table in the center.
- d. Re-tighten hex. bolts for trunnion, recheck the saw blade position.

2. SETTING TABLE SQUARE TO SAW BLADE

Loosen the wing nut on the lower table trunnion and place a suitably sized square against the saw blade. If the table requires adjustment, proceed as follows:

- a. Using a wrench, release the hex. nut on the frame. (See Fig.8)
- b. Place the wrench on the hex. bolt and adjust until the table square to the saw blade.(See Fig.8)

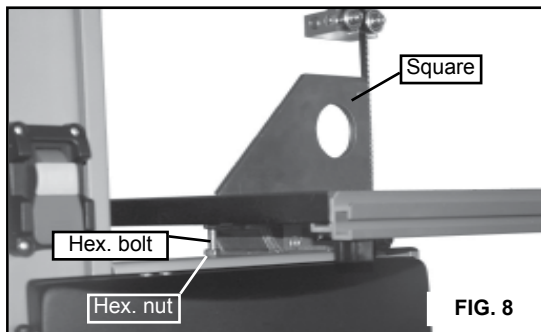

- c. Tighten the hex nut and check the blade and table for squareness.
- d. Lock the table into position and check that the indicator reads zero degree on the side of lower table trunnion. Loosen the screw securing the indicator and reset if necessary to give zero degree reading. (See Fig. 9)

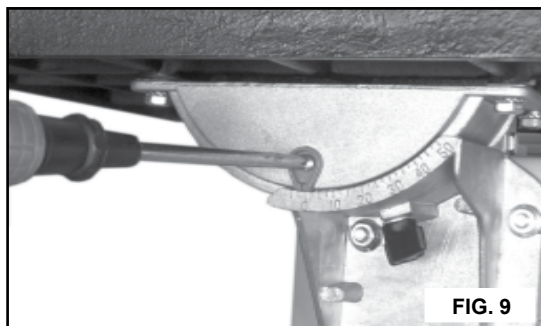

3. TILTING THE TABLE

For bevel cuts, the table tilts 0 through 45 degrees.

a. To tilt the table, loosen the wing nut on the table trunnion, set the table to the required angle and tighten the wing nut again (Fig. 10).

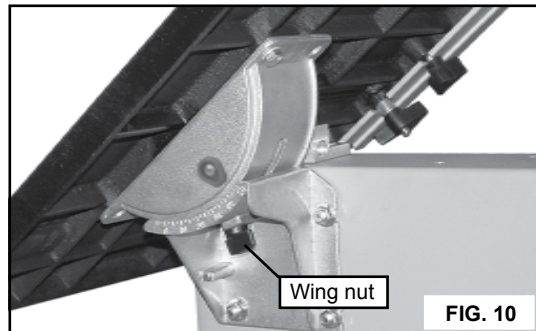

b. It is recommended to verify the correct angle setting using an angle guide, or by making trial cuts in scrap wood. Adjust the indicator accordingly by using a phillips head screwdriver.

4. ADJUSTING THE RIP FENCE

The locking pressure of the rip fence has been factory-set, if adjustment is required proceed as follows:

- a. Raise the fence handle to horizontal position.
- b. Turn the fence handle clockwise to increase clamping pressure, counterclockwise to decrease clamping pressure.(See Fig. 11)
- c. After counterclockwise truning the fence handle, sliding the rip fence to the desired position on the guide rail.(See Fig. 11)
- d. The fence handle has a cam action, press down the handle to clamp tightly to the table after setting rip fence to desired position.

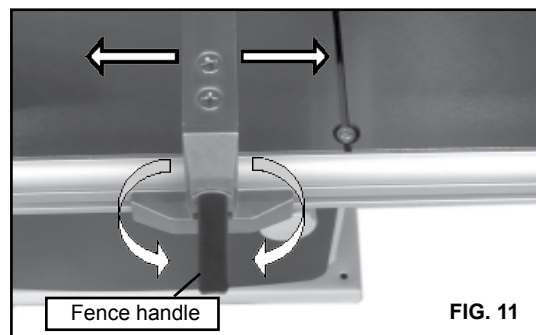

NOTE: Do not adjust the fence handle such that excessive pressure is exerted during operation - this may lead to deformation of the end clamp at the rear of the rip fence. Set the fence handle to apply just enough pressure to enable safe operation during cutting.

5. CHANGING AND ADJUSTING THE SAW BLADE

This bandsaw is factory-equipped with a general-purpose wood cutting blade, the saw blade is set prior to delivery. To change the saw blade, the following procedure must be followed:

WARNING: To avoid injury from unexpected starting, whenever changing the saw blade or carrying out adjustments, switch the bandsaw off and remove the power cord from the main outlet. To avoid injury to hands when handling the saw blade, wear gloves whenever necessary.

- Remove the rip fence, the guide rail, the wing nut and screw from the table.
- Open the upper and lower doors by turning the door locking knobs.
- Loosen the blade tension by turning the blade tension knob on the top of the upper wheel housing counterclockwise until the saw blade has slackened (viewed from above) (See Fig. 12).

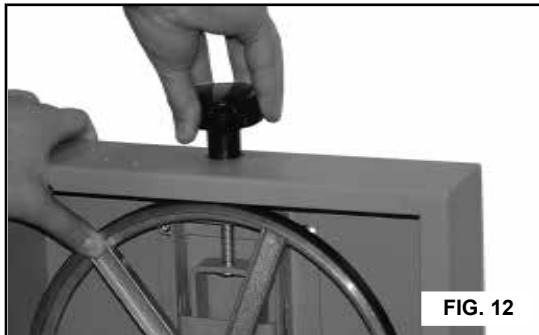

- Remove the saw blade from the upper and lower wheels.
- When fitting the new saw blade ensure the blade teeth are pointing downwards and towards you at the position where the saw blade passes through the table.
- Re-tension the new saw blade and check the saw blade tracking by turning the upper wheel by hand. The saw blade should run in the center of the bandsaw wheels.
- If need adjust the tracking of the saw blade, proceed as mentioned below "TRACKING THE SAW BLADE"
- Replace the rip fence, the guide rail, the wing nut and screw to the table.
- Close the upper and lower doors by turning the door locking knobs before reconnecting the power supply.

6. TRACKING THE BANDSAW BLADE

Set the tracking of the saw blade before setting the blade guides. Once the saw blade is installed and tensioned, track the saw blade by adjusting the tracking knob by hand (See Fig. 13). The saw blade should run in the center of the bandsaw wheels. When the correct adjustment is achieved lock the tracking knob with the wing nut.

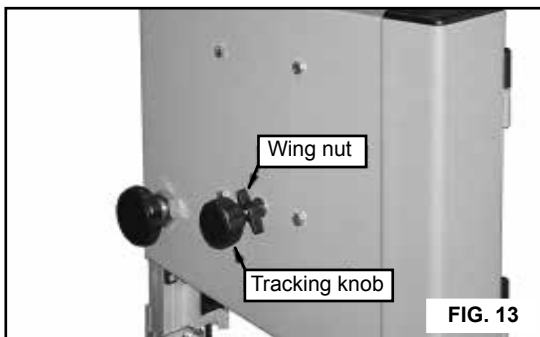

7. SETTING THE CUTTING HEIGHT

- The upper blade guide should be set as close as practical against the workpiece.
- To adjust this height, loosen the wing nut at the side of the upper wheel housing. (See Fig. 14)

- Set the blade guide to the required height by turning the guide post adjusting knob.
- Tighten the wing nut after setting.

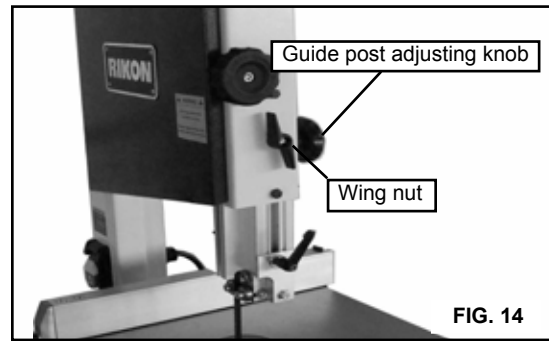

8. ADJUSTING THE BLADE GUIDES

The Upper Blade Guide

- To adjust the upper blade guides, first position the right and left roller guides relative to the blade by slackening the ratchet handle Fig.15 and moving the guide carrier until both roller guides are approximately 1/16" behind the gullets of the saw blade.
- Set both roller guides to within 1/32" of the saw blade by releasing the guide adjusting screw, (A) Fig. 15, on each side of the saw blade. Do not set the roller guides too close as this will adversely affect the life of the saw blade.
- Adjust the rear roller guide to be just clear of the back of the saw blade by unlocking the guide adjusting screw (B) Fig. 15
- When the correct adjustment is reached, lock the rear roller guide in position with the guide adjusting screw (B) Fig.15

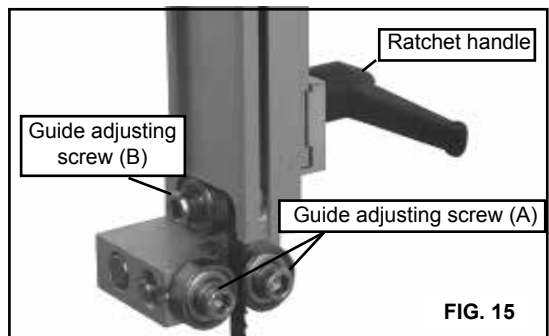

The Lower Blade Guide

- To adjust the lower blade guides, first position the right and left roller guides relative to the blade by slackening the lock nut Fig.16 and moving the guide carrier until both roller guides are approximately 1/16" behind the gullets of the saw blade
- Set both roller guides to within 1/32" of the saw blade by releasing the guide adjusting screw (C) Fig. 16 on each side of the saw blade. Do not set the roller guides too close as this will adversely affect the life of the saw blade.
- Adjust the rear roller guide to be just clear of the back of the saw blade by unlocking the guide adjusting screw. (D) Fig. 16

d. When the correct adjustment is reached, lock the rear roller guide in position with the guide adjusting screw. (D) Fig.16

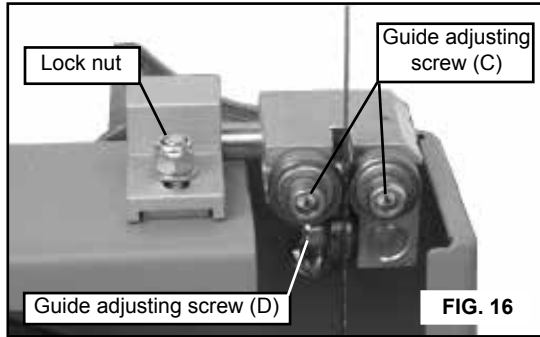

c. Tension the drive belt until there is 3/8" to 1/2" of deflection.
d. Follow procedures for CHANGING AND ADJUSTING THE SAW BLADE & TRACKING THE BANDSAW BLADE, before restoring power to the bandsaw and setting up for use.

9. CHANGING THE DRIVE BELT TENSION

- Release the saw blade tension by turning the blade tension knob on the top of bandsaw counterclockwise.
- Using a M6 hex. "L" wrench (not provided) to release the hex. socket head cap screw on motor mounting flange. (See Fig. 17)

OPERATION

WARNING: Before starting check if any part of your bandsaw is missing, malfunctioning, has been damaged or broken... such as the motor switch, or other operation control, a safety device or the power cord, turn the bandsaw off and unplug it until the particular part is properly repaired or replaced.

The saw blade cuts on a continuous downstroke. To avoid injury when hands are unavoidably near to the saw blade, they should be placed on either side of the blade, not in line with it. Use a push stick whenever possible when working in close proximity to the saw blade.

Start the bandsaw by turning the lock switch on and wait for the bandsaw to come to full speed before starting to cut. Never start the bandsaw with the workpiece in contact with the saw blade.

Slowly feed the workpiece towards the saw blade, putting only light pressure on it. With both hands, firmly hold the workpiece down on the table, and feed it towards the saw blade slowly.

For best results the saw blade must be sharp. Select the right saw blade for the job, depending on the thickness of the wood the cut to be made. The thinner and harder the wood, the finer the teeth of the saw blade. Use a fine tooth blade for cutting sharp curves.

The machine is especially suited for cutting curves, but will also make straight cuts. Do not attempt to turn the workpiece without pushing it, as this may cause the workpiece to get stuck, or the saw blade to bend.

The rip fence is to enable safe and accurate straight cuts of the workpiece, usually in the same direction as the grain of the timber.

A miter gauge (available separately) is to enable safe and accurate crosscut of the workpiece.

The tiltable table is used for bevel cuts.

WARNING: When sawing with the rip fence and a tilted table, the rip fence must be installed on that side of the table which is tilted downward.

MAINTENANCE

WARNING: To avoid injury due to unexpected starting, before cleaning or carrying out maintenance work, switch off and disconnect the bandsaw from the power source.

Never use water or other liquids to clean the bandsaw. Use a dry brush.

Regular maintenance of the bandsaw will prevent unnecessary problems.

- Keep the table clean to ensure accurate cutting.
- Keep the outside of the machine clean to ensure accurate operation of all moving parts and prevent excessive wear.
- Keep the ventilation slots of the motor clean to prevent it from overheating.
- Keep the inside (near the saw blade, etc.) clean to prevent accumulation of dust. Use dust collection if possible.
- To prolong the life of the saw blade, when the bandsaw is not in use for extended periods, release the saw blade tension. Before reusing the bandsaw ensure that the blade is re-tensioned and tracking is checked.

ELECTRICAL SCHEMATIC

WARNING: This machine must be grounded. To avoid electrocution or fire, any repairs to electrical system should be done only by a qualified electrician, using genuine replacement parts.

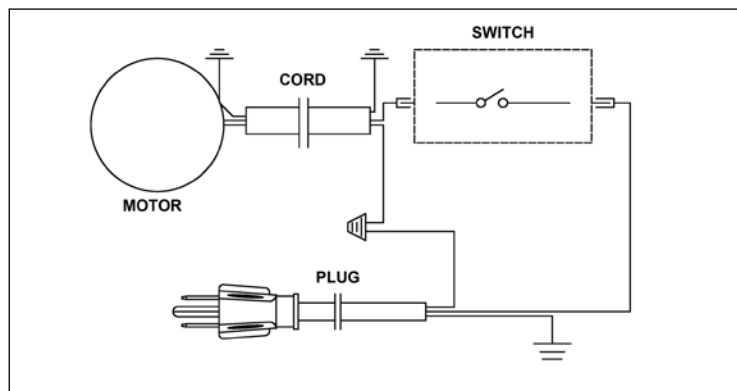

TROUBLESHOOTING

Problem	Diagnosis	Remedy
The machine does not work when switched on.	<ol style="list-style-type: none"> 1. No power supply. 2. Defective switch. 3. Defective motor. 	<ol style="list-style-type: none"> 1. Check the cable for breakage. 2. Replace the lock switch. 3. Defective motor.
The saw blade does not move with the motor running.	<ol style="list-style-type: none"> 1. The blade tension knob has not been tightened. 2. The blade has come off one of the wheels. 3. The saw blade has broken. 4. The drive belt has snapped. 	<ol style="list-style-type: none"> 1. Switch off the motor, tighten the blade tension knob. 2. Open the doors and check. 3. Replace the blade. 4. Replace the belt.
The saw blade does not cut in a straight line.	<ol style="list-style-type: none"> 1. Rip fence for cutting not used. 2. Feed rate too fast. 3. The blade teeth are dull or damaged. 4. Blade guides not suitably adjusted. 	<ol style="list-style-type: none"> 1. Use a rip fence. 2. Put light pressure on the workpiece. Make sure the saw blade does not bend. 3. Try a new saw blade. 4. Adjust the blade guides (see ADJUSTMENT instructions).
The saw blade does not cut, or cuts very slowly.	<ol style="list-style-type: none"> 1. The teeth are dull, caused by cutting hard material or long use. 2. The saw blade was fitted the wrong way on the bandsaw. 	<ol style="list-style-type: none"> 1. Replace the saw blade, use a 6 T.P.I. saw blade for wood and soft material. Use a 14 T.P.I. saw blade for harder materials. A 14 T.P.I. saw blade always cuts slower due to the finer teeth and the slower cutting performance. 2. Fit the saw blade correctly.
Sawdust builds up inside the machine.	This is normal	Clean the machine regularly. Open the doors and remove the sawdust with a vacuum cleaner.
Sawdust inside the motor housing.	This is normal	Clean the ventilating slots of the motor with a vacuum cleaner. From time to time remove the sawdust to prevent it from being drawn into the housing.
The machine does not cut at 45 or 90 degrees.	<ol style="list-style-type: none"> 1. The table is not at right angles to the blade. 2. The saw blade is dull or too much pressure was put on the workpiece. 	<ol style="list-style-type: none"> 1. Adjust the table. 2. Replace the saw blade or put less pressure on the workpiece.

TROUBLESHOOTING

CHANGING THE MOTOR DRIVE BELT

(Refer to parts diagram on page 16)

Before changing the belt, make sure that the bandsaw is unplugged from the power source.

Release the saw blade tension from the drive belt by turning the tension knob (Part #16) counter clockwise on top of the saw.

Release the drive belt tension by loosening the Hex. Socket Head Cap Screw M8x30 (Part #125) on the motor located at the rear of the saw.

Remove the lower wheel (Wheel Assembly, Part #138) by removing the retaining ring (Part #140) in the middle of the wheel's hub. Carefully slide the lower wheel off of the lower wheel shaft, and at the same time remove the saw blade from this wheel.

Remove the old drive belt from the wheel's pulley, and install the new belt. Make sure that the ribs in the drive belt are seated correctly in the pulley before reassembling and tensioning the drive belt.

Reverse the procedure to re-assemble the saw parts. Tension the drive belt until there is 3/8" to 1/2" of deflection.

CHANGING BANDSAW TIRES

Use a putty knife to get underneath the tire and pull it up and away from the wheel. Work the putty knife all the way around the wheel to loosen the tire. Then, use the putty knife as leverage to flip the tire over and off of the wheel. Clean the inside of the groove, removing any dirt, debris or cement with lacquer thinner.

Soak the replacement tire in warm water to make it more flexible. Dry the tire, and while it is still warm, lay it on top of the wheel. Start by setting the tire into the wheel groove at the top of the wheel. Using a putty knife, work the new tire around the wheel, making sure not to slice the tire. If rubber cement is to be used as a binder, make sure to distribute it evenly. Having high spots between the wheel and the tire will cause a vibration and effect blade tracking.

TROUBLESHOOTING

LOWER WHEEL ADJUSTMENTS

The following instructions will correct common blade issues related to the lower wheel's alignment in relation to the upper wheel. These adjustments will correct the blade position on the lower wheel and blade oscillation (wobble). These are critical adjustments which affect the performance and accuracy of the bandsaw.

⚠ CAUTION PLEASE READ AND UNDERSTAND THESE STEPS THOROUGHLY BEFORE MAKING ANY ADJUSTMENTS. FAILURE TO DO SO COULD DAMAGE THE MACHINE.

Please contact a tech support representative if you have questions before attempting these adjustments. RIKON Tech Support 877-884-5167 techsupport@rikontools.com

Release the blade tension completely before making any lower wheel adjustments. Pressure must be released on the lower wheel to allow proper adjustments and to avoid damaging the machine.

If the blade is not running true, or it is not running on center of the lower wheel but is correct on the upper wheel, then an adjustment to the wheel hub on the rear of the bandsaw is required.

The numbers shown on the rear hub photo represent the positions on a clock face.

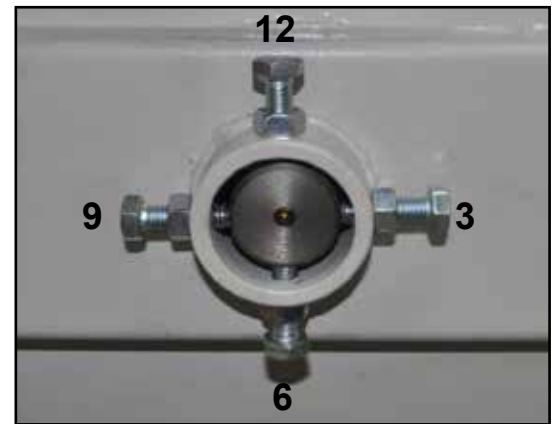

If a blade is tracking forward on the lower wheel toward the door, follow these correction steps:

- 1.) De-tension the saw blade.
- 2.) Loosen 9 o'clock shaft bolt to take pressure off the shaft.
- 3.) Loosen 12 o'clock shaft bolt one half rotation.
- 4.) Tighten the 6 o'clock shaft bolt until the shaft touches the 12 o'clock adjusting bolt.
- 5.) Lock all three shaft bolts.
- 6.) Re-tension the saw blade and set the upper wheel to plumb by adjusting the tracking knob. Spin the upper wheel by hand and track the blade.
- 7.) Repeat if further adjustment is necessary.

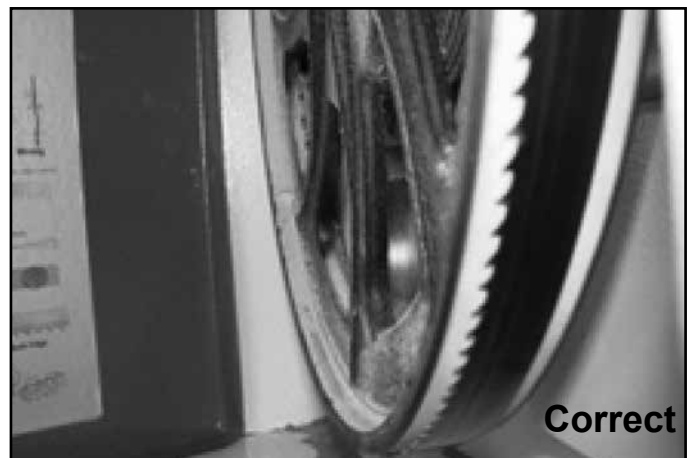
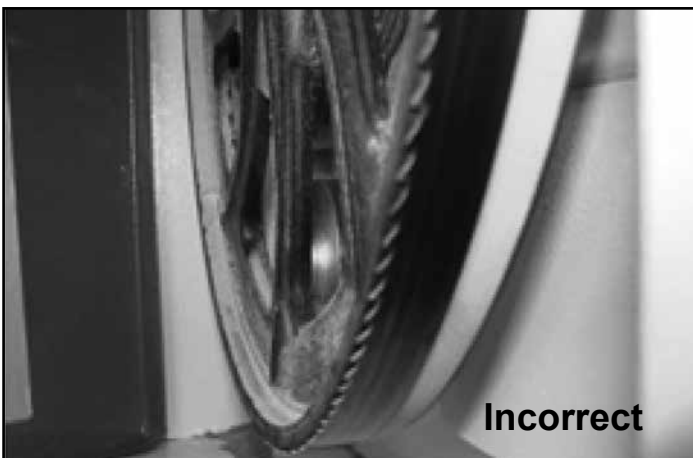

TROUBLESHOOTING

If a blade is tracking on the rear of the lower wheel, away from the door, follow these steps:

- 1.) De-tension the saw blade.
- 2.) Loosen 9 o'clock shaft bolt to take pressure off the shaft.
- 3.) Loosen 6 o'clock shaft bolt one half rotation.
- 4.) Tighten the 12 o'clock shaft bolt until the shaft touches the 6 o'clock adjusting bolt.
- 5.) Lock all three shaft bolts.
- 6.) Re-tension the saw blade and set the upper wheel to plumb by adjusting the tracking knob. Spin the upper wheel by hand and track the blade.
- 7.) Repeat if further adjustment is necessary.

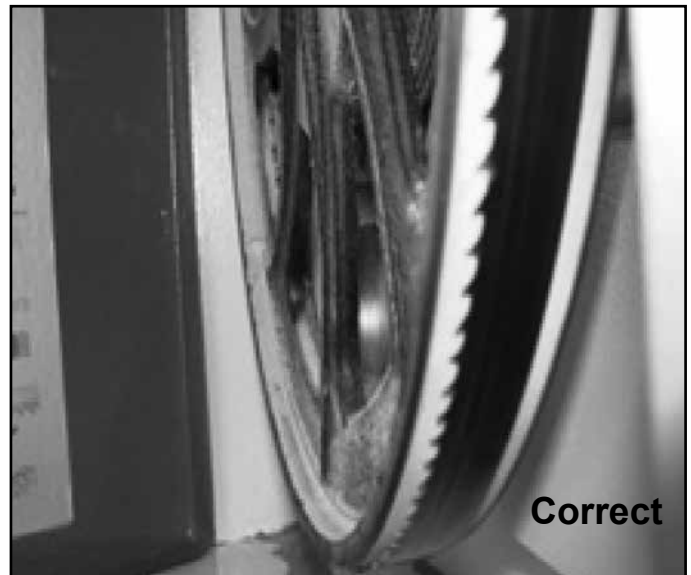

If a blade is moving back and forth (wobbling) follow these steps:

Adjustment to the wheel hub on the rear of the bandsaw is required.

- 1.) De-tension the saw blade.
- 2.) Loosen 6 o'clock shaft bolt to take pressure off of the shaft.
- 3.) Loosen 9 o'clock shaft bolt one half rotation.
- 4.) Tighten the 3 o'clock shaft bolt until the shaft touches the 9 o'clock adjusting bolt.
- 5.) Lock all three shaft bolts.
- 6.) Re-tension the saw blade and set the upper wheel to plumb by adjusting the tracking knob. Spin the upper wheel by hand and track the blade.
- 7.) Start the bandsaw and check blade movement.
- 8.) If movement has diminished then continue with the adjustment.
- 9.) If movement is worse, reverse the adjustments in steps 3 and 4.

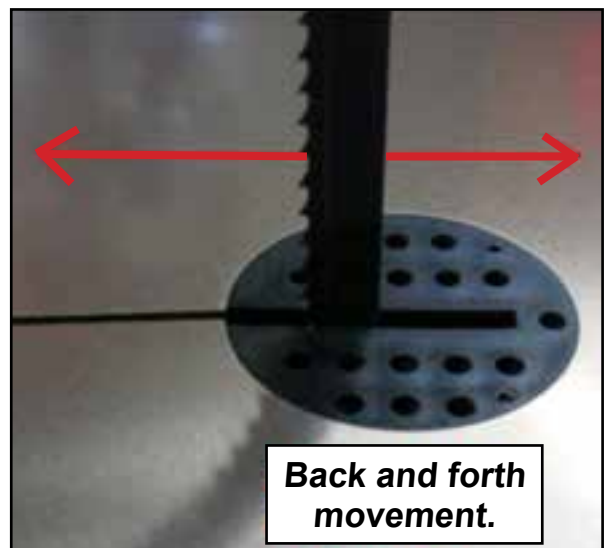

PARTS DIAGRAM

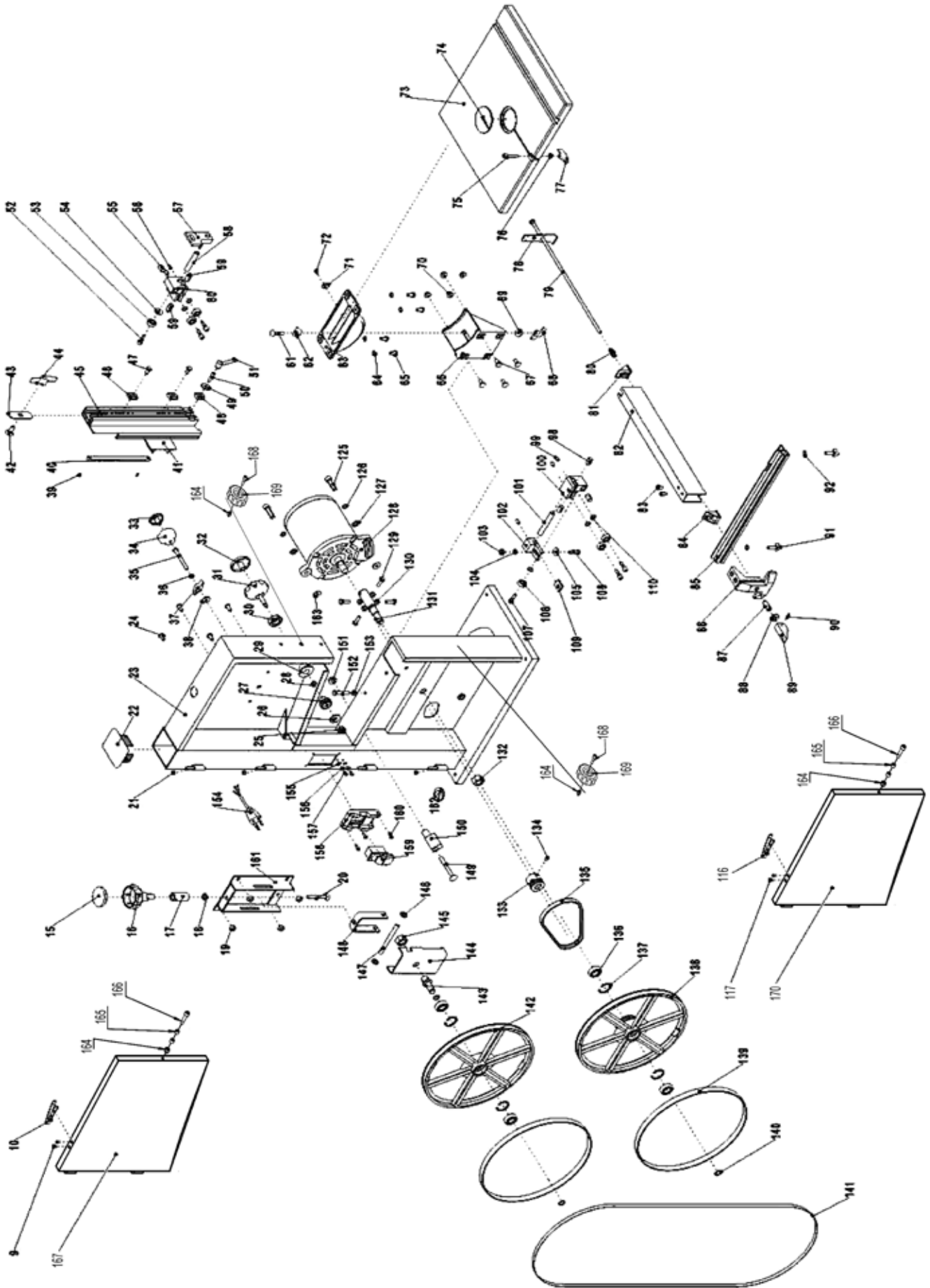

PARTS LIST

KEY NO.	DESCRIPTION	MFG. PART NO.	KEY NO.	DESCRIPTION	MFG. PART NO.
9	Rivet 4x8	P10-305-9	48	T-nut M6	P10-305-48
10	Leaf Spring	P10-305-10	49	Washer 6	P10-305-49
15	Blade Tension Knob Cap	P10-305-15	50	Hex. Socket Set Screw M6x25	P10-305-50
16	Blade Tension Knob Body	P10-305-16	51	Ratchet handle	P10-305-51
17	Blade Tensioner	P10-305-17	52	Guide Adjust Screw	P10-305-52
18	Washer 8	P10-305-18	53	Ball Bearing 6mm	P10-305-53
19	Flange Nut M6	P10-305-19	54	Washer 6	P10-305-54
20	Carriage Bolt M8x50	P10-305-20	55	Bearing Mount Cylinder	P10-305-55
21	Bushing Ring	P10-305-21	56	Hex. Socket Set Screw M6x10	P10-305-56
22	Top Plug	P10-305-22	57	Upper Guide Mount	P10-305-57
23	Frame	P10-305-23	58	Upper Guide Shaft	P10-305-58
24	Hex. Bolt M6x12	P10-305-24	59	Bearing Mount Cylinder w/Cap	P10-305-59
25	Lock Nut M6	P10-305-25	60	Upper Guide Body	P10-305-60
26	Washer 6	P10-305-26	61	Carriage Bolt M6x30	P10-305-61
27	Gear	P10-305-27	62	Glide Piece	P10-305-62
28	Special Spring Washer 8	P10-305-28	63	Upper Table Trunion	P10-305-63
29	Tube	P10-305-29	64	Lock Washer 6	P10-305-64
30	Plastic Nut M20	P10-305-30	65	Hex. Bolt M6x12	P10-305-65
31	Adjusting Knob Body	P10-305-31	66	Lower Table Trunion	P10-305-66
32	Adjusting Knob Cap	P10-305-32	67	Carriage Bolt M6x16	P10-305-67
33	Blade Tracking Knob Cap	P10-305-33	68	Wing Nut M6	P10-305-68
34	Blade Tracking Knob Body	P10-305-34	69	Washer 6	P10-305-69
35	Hex. Bolt M6x60	P10-305-35	70	Flange Nut M6	P10-305-70
36	Hex. Nut M6	P10-305-36	71	Indicator	P10-305-71
37	Wing Nut M6	P10-305-37	72	Tapping Screw ST3.5x9.5	P10-305-72
38	Washer 6	P10-305-38	73	Table	P10-305-73
39	Tapping Screw ST3.5x13	P10-305-39	74	Table Insert	P10-305-74
40	Rack	P10-305-40	75	Hex. Socket Head Cap Scr M6x30	P10-305-75
41	Slider	P10-305-41	76	Washer 6	P10-305-76
42	Carriage Bolt M8x20	P10-305-42	77	Wing Nut M6	P10-305-77
43	Bolt Guide	P10-305-43	78	Fence Clamper	P10-305-78
44	Wing Nut M8	P10-305-44	79	Threaded Rod	P10-305-79
45	Blade Guide	P10-305-45	80	Spring	P10-305-80
46	T-nut M6	P10-305-46	81	Rod Guide	P10-305-81
47	Hex. Bolt M6x10	P10-305-47	82	Fence	P10-305-82

NOTE: Please reference the Manufacturer's Part Number when calling for Replacement Parts.
For Parts under Warranty, the serial number of your machine is required.

PARTS DIAGRAM

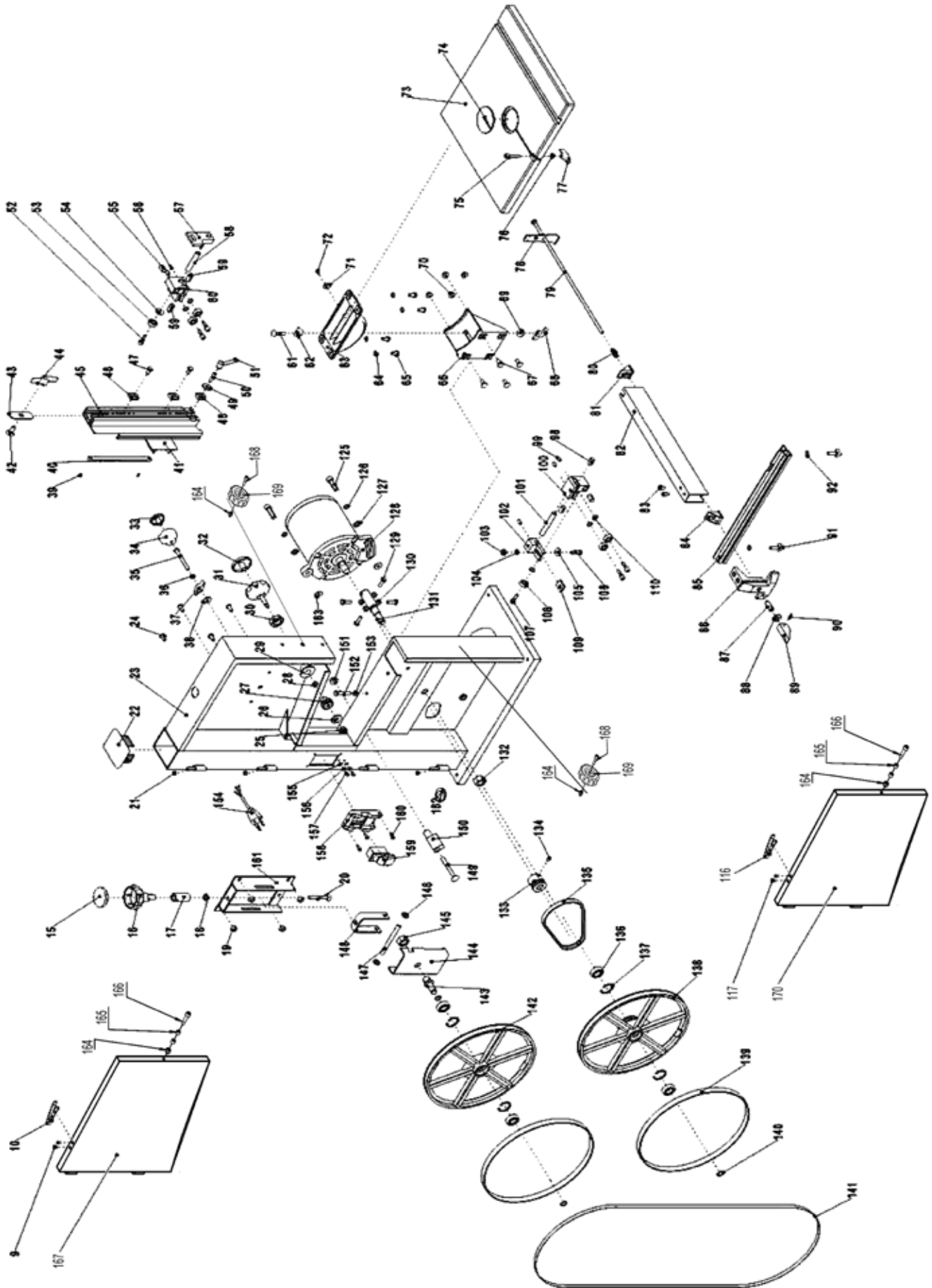

PARTS LIST

KEY NO.	DESCRIPTION	MFG. PART NO.	KEY NO.	DESCRIPTION	MFG. PART NO.
83	Flat Countersunk Scr M6x10	P10-305-83	135	Drive Belt	P10-305-135
84	Rod Guide	P10-305-84	136	Ball Bearing 12mm	P10-305-136
85	Guide Rail	P10-305-85	137	Retaining Ring 28	P10-305-137
86	Fence Carrier	P10-305-86	138	Lower Wheel	P10-305-138
87	Special Screw	P10-305-87	139	Tire	P10-305-139
88	Washer 10	P10-305-88	140	Retaining Ring 12	P10-305-140
89	Fence Handle	P10-305-89	141	Saw Blade	P10-305-141
90	Roll Pin 3x18	P10-305-90	142	Upper Wheel	P10-305-142
91	Star knob screw	P10-305-91	143	Upper Bearing Bolt	P10-305-143
92	Washer 6	P10-305-92	144	Wheel Carrier Bracket	P10-305-144
98	Bearing Mount Cylinder	P10-305-98	145	Hex. Nut M14	P10-305-145
99	Hex. Socket Set Screw M6x10	P10-305-99	146	Star Lock	P10-305-146
100	Lower Guide Body	P10-305-100	147	Mount Shaft	P10-305-147
101	Lower Guide Shaft	P10-305-101	148	Blade Tensioner	P10-305-148
102	Lower Guide Mount	P10-305-102	149	Carriage Bolt M8x65	P10-305-149
103	Lock Nut M6	P10-305-103	150	Brush Strip	P10-305-150
104	Washer 6	P10-305-104	151	Flange Nut M8	P10-305-151
105	Washer 6	P10-305-105	152	Hex. Bolt M6x35	P10-305-152
106	Hex. Bolt M6x20	P10-305-106	153	Hex. Nut M6	P10-305-153
107	Guide Adjust Screw	P10-305-107	154	Cable w/Plug	P10-305-154
108	Ball Bearing 6mm	P10-305-108	155	Lock Washer 4	P10-305-155
109	Guide Key	P10-305-109	156	Washer 4	P10-305-156
110	Washer 6	P10-305-110	157	Pan Head Screw M4x8	P10-305-157
115	Lower Door	P10-305-115	158	Switch Cover Plate	P10-305-158
116	Leaf Spring	P10-305-116	159	Lock Switch	P10-305-159
117	Rivet 4X8	P10-305-117	160	Pan Head Screw M4x12	P10-305-160
125	Hex. Socket Hd Cap Scr M8x30	P10-305-125	161	Tension Bracket	P10-305-161
126	Spring Washer 8	P10-305-126	162	Rubber Tube	P10-305-162
127	Washer 8	P10-305-127	163	Washer 8	P10-305-163
128	Motor	P10-305-128	164	Nut	P10-305-164
128A	Motor Capacitor (not shown)	P10-305-128A	165	Bushing	P10-305-165
129	Hex. Bolt M6x20	P10-305-129	166	Hex Screw	P10-305-166
130	Hex. Nut M6	P10-305-130	167	Upper Door	P10-305-167
131	Lower Bearing Bolt	P10-305-131	168	Hex Screw	P10-305-168
132	Hex. Nut M14	P10-305-132	169	Handle	P10-305-169
133	Motor Pulley	P10-305-133	170	Lower Door	P10-305-170
134	Hex. Socket Set Scr M6x10	P10-305-134			

NOTE: Please reference the Manufacturer's Part Number when calling for Replacement Parts.
For Parts under Warranty, the serial number of your machine is required.

NOTES

Use this section to record maintenance, service and any calls to Technical Support.

ACCESSORIES



13-913 10" Bandsaw Stand



13-920 Miter Gauge



C10-393 Table Insert (4pk)



Bandsaw Blades

Where to buy: Contact RIKON at 877-884-5167
or info@rikontools.com.

How-To's for all Band Saw Blades

Choosing the Correct Blade Width

Blade width is measured from the tips of the teeth to the back edge of the blade as shown above. The instructions for the particular machine being used should be followed when selecting blade width.



If no such instructions are provided, blade width should be determined with the following guidelines:

For Cut-Off Sawing, the blade should be as wide as the machine will allow. The wider the band is, the straighter the cut will be. Faster feeding can be achieved.

For Contour Sawing, the blade should be as wide as the machine allows, but still narrow enough so that it can cut the desired shape (radius). Minimum dimensions for different cutting radii are shown on the chart at right.

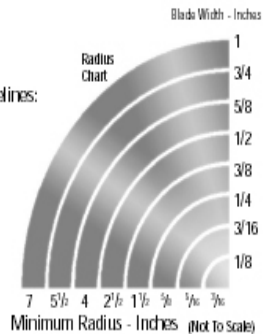

How To Choose The Correct Number Of Teeth Per Inch (TPI)

The number of teeth per inch (TPI) is important in obtaining the finish desired and the proper feed rate. A coarse tooth blade (2, 3 TPI) should be used for resawing wood and cutting thicker stock up to 8". A fine toothed blade (18 to 32 TPI) should be used for thinner metals and plastics under 1/4". For general cutting of 3/4" wood 4 TPI will provide a fast cut and 14 TPI will cut slow, but leave a smoother finish.

When Selecting TPI remember:

- More TPI give a smoother but slower cut
- Fewer TPI allow a faster cut with a slightly rougher finish
- At least three teeth must be in the workpiece—the chart to the right will help you decide.

TPI	Minimum Material Thickness
32	3/32"
24	1/8"
18	5/32"
14	1/4"
10	5/16"
8	3/8"
6	1/2"
4	3/4"
3	1"
2	1-1/2"

It is important to know the SFM for the various speed settings of your band saw, so that you can select the proper speed for cutting wood or other materials. Check the operator's manual of your band saw to determine the SFM or use the following procedure:

1. Determine the RPM: check the operator's manual or clock the revolutions per minute of the wheels with a tachometer or revolution counter.
2. Measure the diameter of the drive wheel in inches and multiply by .262 to obtain the wheel circumference. The RPM times circumference equals the surface speed of the blade.
RPM x diameter in inches x .262 = SFM.

Note: Spring Steel Wood Cutting Band Saw Blades should never be operated at surface speeds above 3000 SFM. Carbon Hard Edge Flexible Back Band Saw Blades may be run up to 8000 SFM.

Installing your Band Saw Blade

1. Unplug the saw, then loosen the tension on the upper wheel. With all the blade guides backed off, slip the new blade around the wheels and then tension it.
2. When you have tensioned the blade enough to keep it on the wheels, track it by turning the upper wheel with one hand while adjusting the tilt of the wheel's axis with the other hand. The blade should ride in the middle of the rim. **Never track the blade with the motor running and the cover open.**
3. Next, adjust the blade guides; first the thrust bearings; upper and lower, then the left and right side guides.
4. Use a square to make sure you are not pushing the blade out of line and place a piece of white paper between the blade guide and the blade to allow for clearance.

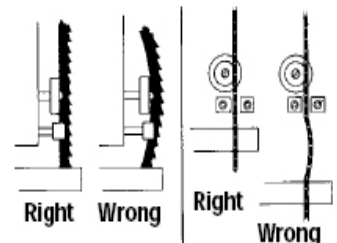

Diagnosing Problems

1. Premature and Excessive Tooth Wear

- Feed pressure too light, increase it.
- Lower band velocity.
- Improper tooth selection, use a finer pitch.
- Improper break-in with new band. Velocity and feeding should be reduced the first few cuts.
- Teeth are running the wrong direction.
- Be sure teeth are pointing in proper direction.
- Incorrect saw guide insert size for the band, allowing them to strike teeth

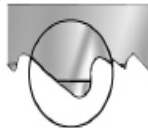

2. Blade Vibration

- Increase or decrease band velocity.
- Teeth too coarse for workpiece.
- Material not securely held.
- Increase tension of band.
- Increase feed pressure.

3. Gullets Loading

- Teeth too fine for workpiece - use a coarser pitch.
- Decrease band velocity.

4. Band Stalls in Work

- Feed pressure too great - decrease feed.
- Teeth too coarse, use finer tooth blade

5. Premature Blade Breakage

- Thickness of blade too heavy for diameter of wheels and speed of machine
- Increase or decrease velocity
- Check wheels for defects
- Teeth too coarse for workpiece - use a finer pitch
- Decrease blade tension - Decrease feeding force
- Brittle weld - increase annealing period, decreasing heat gradually
- Check for proper adjustment of band guides, saw guides, saw guide inserts and back-up bearings.

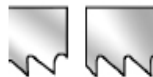

6. Blade Making Belly-Shaped Cuts

- Increase tension.
- Adjust guides closer to workpiece.
- Teeth too fine - use a coarse pitch.
- Decrease feed force.
- Teeth dull.



7. Tooth Strippage

- Teeth too coarse for workpiece.
- Material not securely held.
- Too much feed pressure - reduce for good chip curl.
- Band velocity too low - increase speed.



8. Band Develops a Negative Camber

- Band is riding on saw guide backup bearing too heavily. Adjust band for alignment on top and bottom wheels.
- Check band wheel alignment.



9. Blade Not Running True Against Saw Guide Backup Bearing

- If clicking noise against saw guide backup bearing, remove burr on band.
- Check band wheel alignment.
- Check saw guide backup bearing for wear, replace if necessary
- Weld not in proper alignment. Reweld blade straight and true.

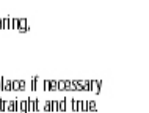

10. Cutting Rate Too Slow

- Increase band velocity.
- Increase feed pressure.
- Use a coarser pitch.



11. Blade Leading In Cut

- Reduce feed pressure or rate.
- Check adjustments and wear of saw guides or rollers.
- Lack of band tension.
- Tooth set damage.

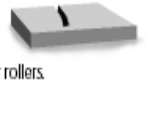

12. Premature Loss of Set

- Improper width selection - check chart for correct width for radius cutting.
- Reduce band velocity.

13. Band Develops Positive Camber

- Decrease force.
- Use a coarser pitch to increase tooth penetration.
- Adjust saw guides closer to work.



14. Band Develops Twist

- Wrong width for radius being cut - choose a narrower blade.
- Binding in cut - decrease feed pressure.
- Decrease band tension.
- Adjust saw guides further from workpiece.



15. Finished Cut Surface Too Rough

- Improper tooth selection - choose a finer pitch.
- Increase band velocity.
- Decrease feed rate.



16. Band Scoring (side wear or grooving)

- Check for wear on saw guide inserts.
- Too much pressure on saw guide inserts.
- Check alignment of saw guides - be sure they are square to front vise. Replace or clean guides.



17. Burring or Mushrooming of Blade Back Edge

- Increase tension and adjust guides.
- Check contact between blade and back edge rollers.
- Reduce feed pressure.
- Use coarser pitch blade.
- Use finishing stone.



RIKON

POWER TOOLS

5-Year Limited Warranty

RIKON Power Tools Inc. ("Seller") warrants to only the original retail consumer/purchaser of our products that each product be free from defects in materials and workmanship for a period of five (5) years from the date the product was purchased at retail. This warranty may not be transferred.

This warranty does not apply to defects due directly or indirectly to misuse, abuse, negligence, accidents, repairs, alterations, lack of maintenance or normal wear and tear. Under no circumstances will Seller be liable for incidental or consequential damages resulting from defective products. All other warranties, expressed or implied, whether of merchantability, fitness for purpose, or otherwise are expressly disclaimed by Seller. This warranty does not cover products used for commercial, industrial or educational purposes.

This limited warranty does not apply to accessory items such as blades, drill bits, sanding discs, grinding wheels or belts and other related items.

Seller shall in no event be liable for death, injuries to persons or property, or for incidental, contingent, special, or consequential damages arising from the use of our products.

To take advantage of this warranty proof of purchase documentation, which includes date of purchase and an explanation of the complaint, must be provided.

The Seller reserves the right to effect at any time, without prior notice, those alterations to parts, fittings, and accessory equipment which they may deem necessary for any reason whatsoever.

To take advantage of this warranty, please fill out the enclosed warranty card and send it to:
RIKON Warranty
16 Progress Rd.
Billerica, MA 01821

The card must be entirely completed in order for it to be valid. If you have any questions please contact us at 877-884-5167 or warranty@rikontools.com.



**For more information:
16 Progress Rd
Billerica, MA 01821**

**877-884-5167 / 978-528-5380
techsupport@rikontools.com**